



Technical Data

Specification & Capacities



MPK50



12,0kW/16,1Hp



2,8-6,9m



5000kg



EN 13000



Via Campardone, 1
31014 Colle Umberto – Italy
Tel. +39 0438 1710083
Mail: info@jekko.it
Web: www.jekko.it

Date	Oct 11 th 2016
REV.	Rev. 5

MPK50 – OVERALL DIMENSIONS

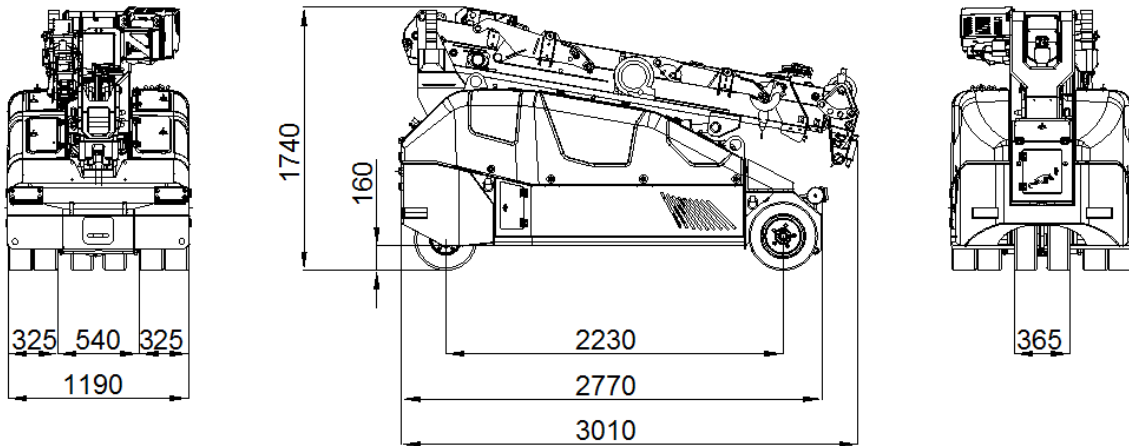

MPK50 - Stabilizing bar

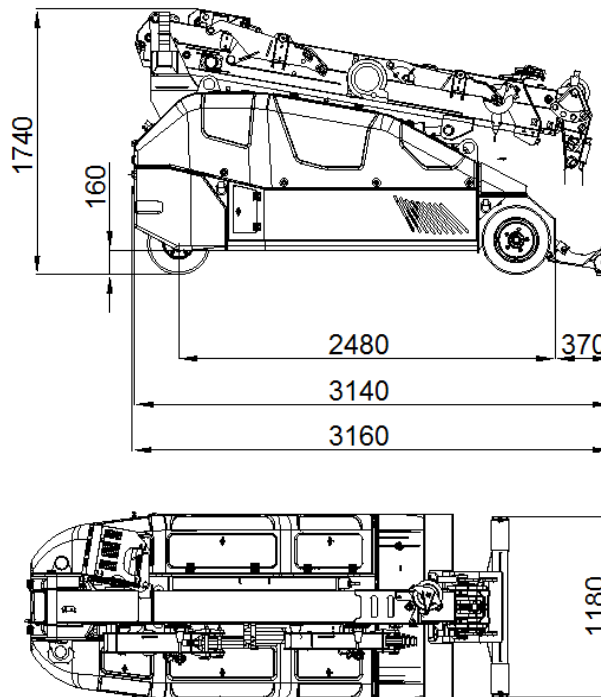

MPK50 – Boom movement

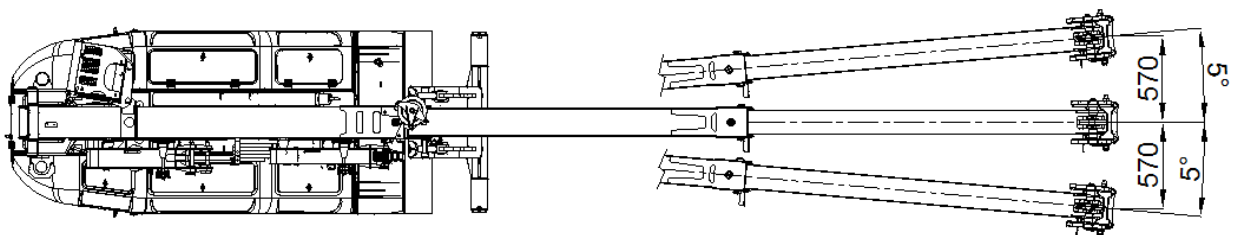



MPK50 – Turning radius

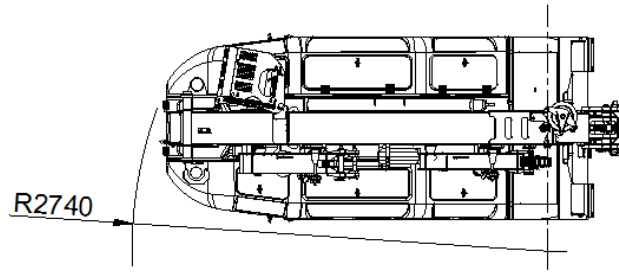

MPK50



		kg
		3450
		1000
Tot.		4450

	48V 620 Ah		12,0kW 16,1Hp
---	------------	---	---------------

	km/h	4,0
	20%	

	-10°/65°	25 sec
	m 2,8 - 6,9	25 sec

Reaction on wheel (double wheel base)

	kg	0
	kg	2600
	kg	1850
	kg	4450

HOIST PERFORMANCE

Layer	Max Line Pull	Normal Line Speed	High Line Speed
	kg	m/min	m/min
1	1.491 (*)	34,4	N/A
2	1.377 (*)	37,5	N/A
3	1.281 (*)	40,6	N/A
4	1.172 (*)	42,8	N/A
5	1.100(*)	45,1	N/A

(*) 1000kg LMI limited

Wire Rope	Diameter	Tot. Length	Max Load
	mm	m	kg
19x7 right lang lay Non rotating	8	60	5.435

HOOK BLOCK

LOAD	No. of	
	Sheaves	Lines
5.000	3	5
4.000	2	4
3.000	2	3
2.000	1	2
1.000		1



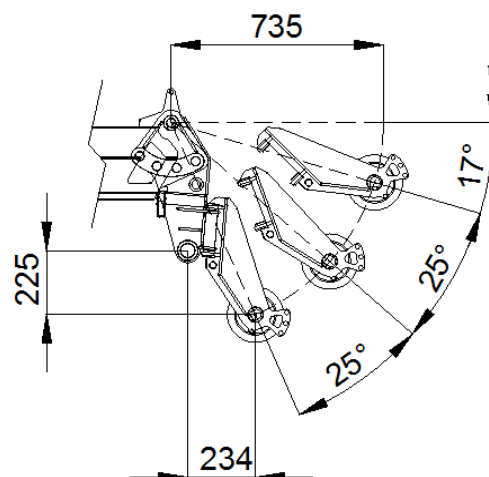
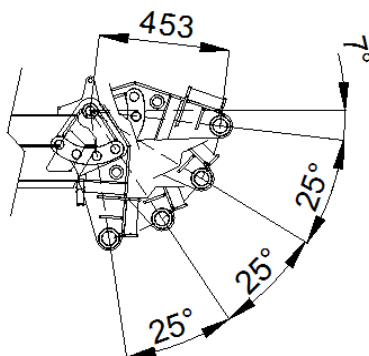



BOOM HEAD CONFIGURATIONS

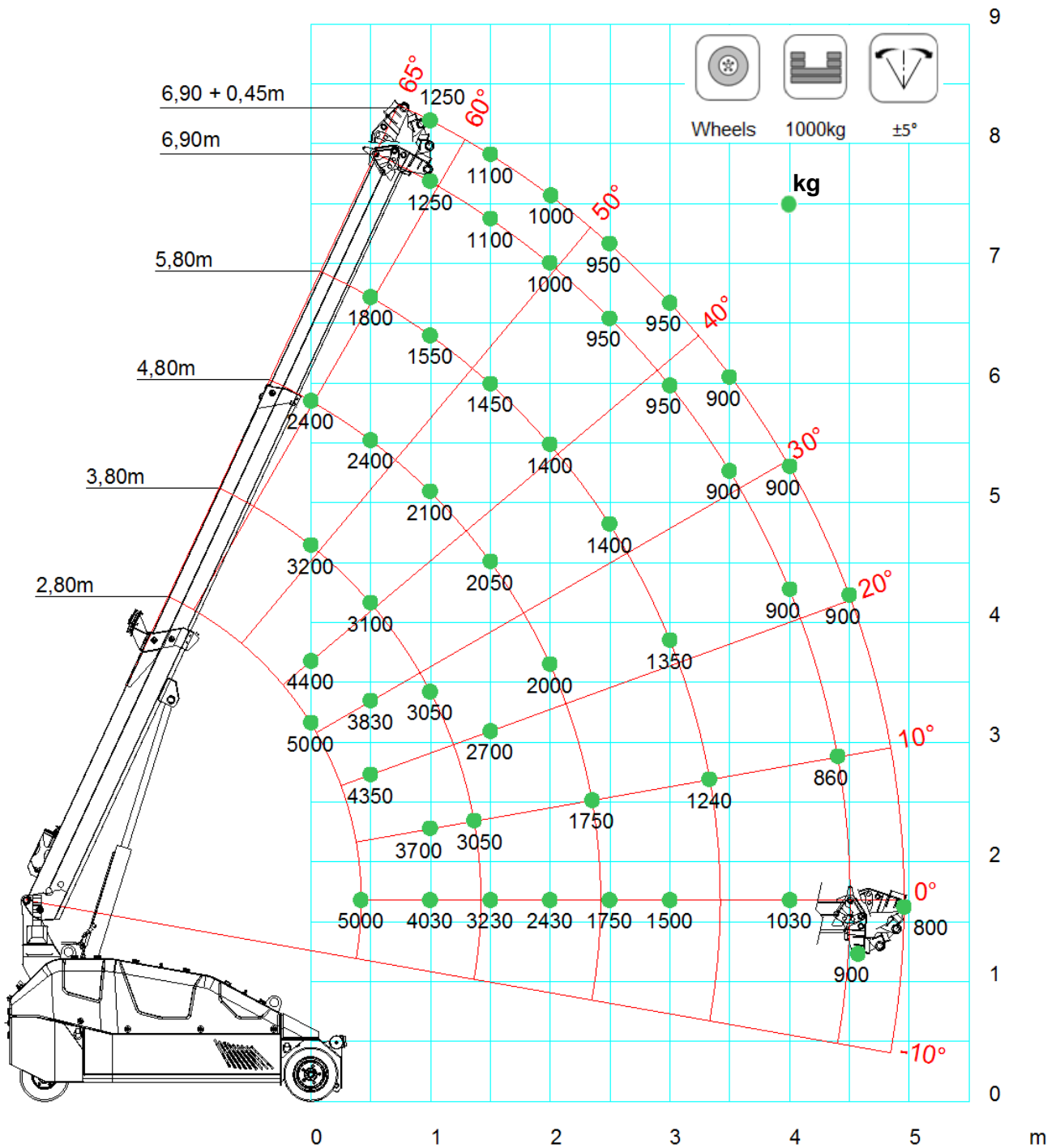









MPK50 MAIN BOOM Hook Wheels



	 HOOK	 Wheels	 1000kg	 ±5°	 EN
	2,8	3,8	4,8	5,8	6,9
0,0	5000	3200	2400		
0,5	5000	3100	2400	1800	
1,0		3050	2100	1550	1250
1,5		3050	2050	1450	1100
2,0			2000	1400	1000
2,5			1750	1400	950
3,0				1350	950
3,5				1200	900
4,0					900
4,5					900
4,9					800

LCMPK50_V102_0616_MAIN_A1_G_CW_1000_WHEEL

	 HOOK	 Wheels	 0kg	 ±5°	 EN
	2,8	3,8	4,8	5,8	6,9
0,0	4500	2700	2050		
0,5	4000	2500	1900	1400	
1,0		2200	1600	1300	1175
1,5		1700	1400	1200	1025
2,0			1200	1100	975
2,5			900	850	850
3,0				760	700
3,5				620	600
4,0					500
4,9					450





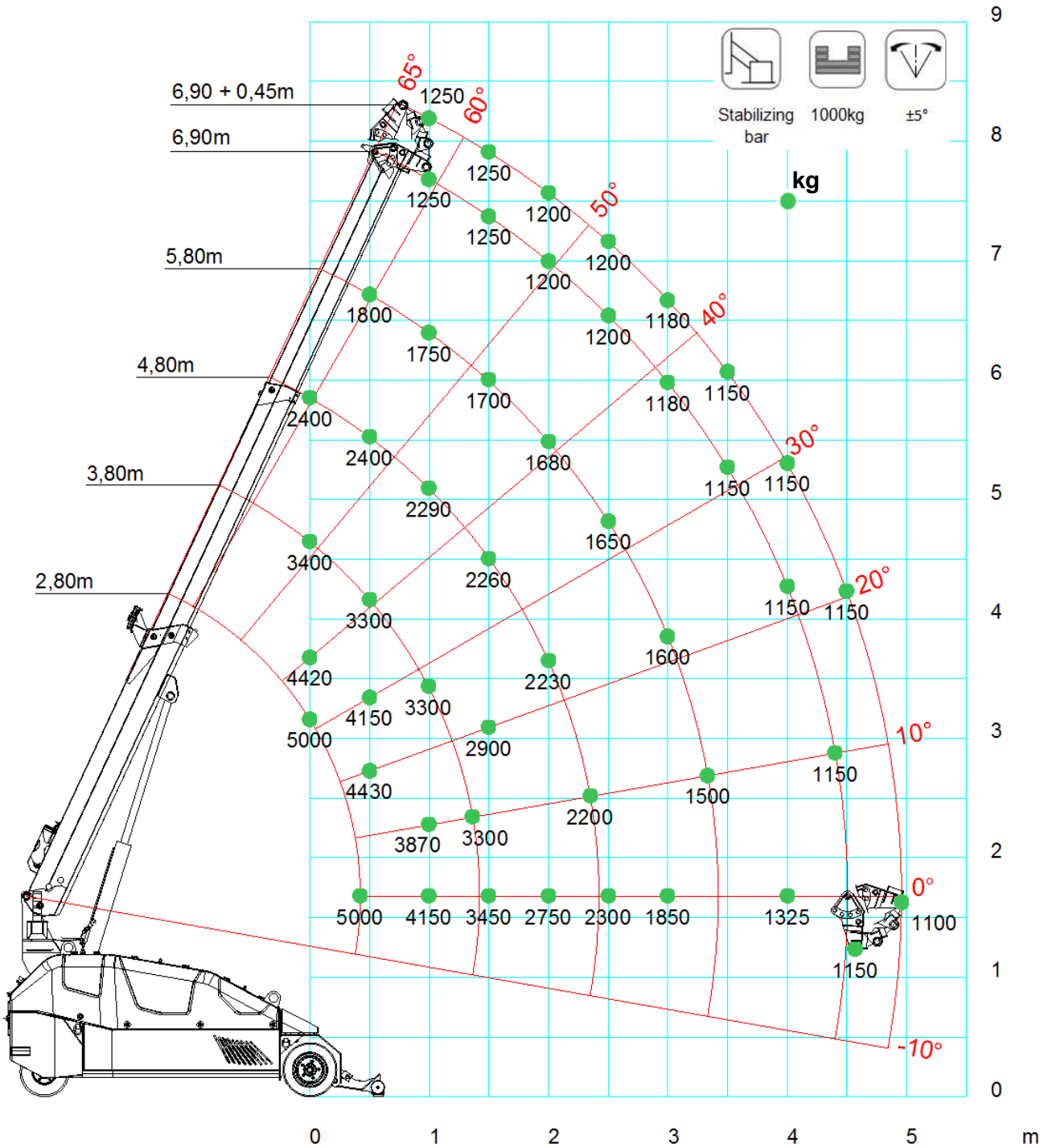

LCMPK50_V102_0616_MAIN_A1_G_CW_0_WHEEL

MPK50 MAIN BOOM Hook Stabilizing bar

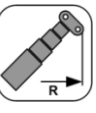

	 HOOK	 Stabilizing bar	 1000kg	 ±5°	 EN
	2,8	3,8	4,8	5,8	6,9
0,0	5000	3400	2400		
0,5	5000	3300	2400	1800	
1,0		3300	2290	1750	1250
1,5		3300	2260	1700	1250
2,0			2230	1680	1200
2,5			2200	1650	1200
3,0				1600	1180
3,5				1500	1150
4,0					1150
4,5					1150
4,9					1100

LCM PK50_V102_0616_MAIN_A1_G_CW_1000_BAR

	 HOOK	 Stabilizing bar	 0kg	 ±5°	 EN
	2,8	3,8	4,8	5,8	6,9
0,0	5000	3000	2220		
0,5	4500	2900	2150	1600	
1,0		2750	1950	1500	1190
1,5		2500	1830	1450	1150
2,0			1700	1380	1115
2,5			1550	1250	1050
3,0				1180	975
3,5				1050	900
4,0					850
4,9					800

LCM PK50_V102_0616_MAIN_A1_G_CW_0_BAR

MPK50 MAIN BOOM Winch Wheels

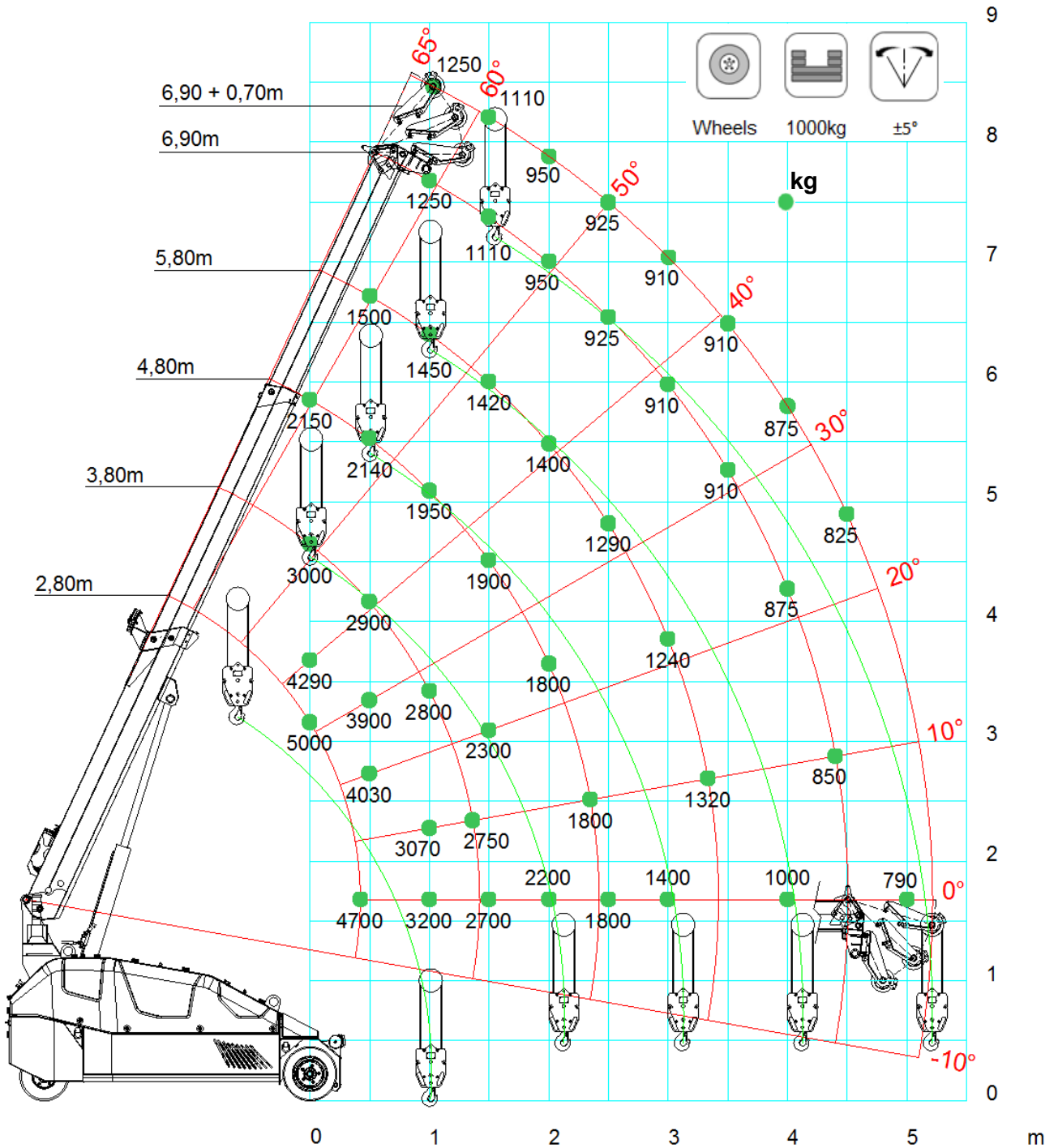

					
	WINCH	Wheels	1000kg	±5°	
	2,8	3,8	4,8	5,8	6,9
0,0	5000	2980	2140		
0,5	4700	2900	2140	1500	
1,0		2820	1940	1440	1250
1,5		2780	1900	1420	1110
2,0			1800	1400	950
2,5			1610	1290	925
3,0				1240	910
3,5				1160	910
4,0					875
4,5					825
4,9					800

LCMPK50_V102_0616_MAIN_A1.F_CW_1000_WHEEL

					
	WINCH	Wheels	0kg	±5°	
	2,8	3,8	4,8	5,8	6,9
0,0	4500	2540	1780		
0,5	3500	2340	1780	1440	
1,0		2080	1600	1340	1025
1,5		1660	1460	1240	925
2,0			1160	960	775
2,5			880	830	710
3,0				680	560
3,5				580	500
4,0					455
4,5					425
4,9					400

LCMPK50_V102_0616_MAIN_A1.F_CW_0_WHEEL

MPK50 MAIN BOOM Winch Stabilizing bar

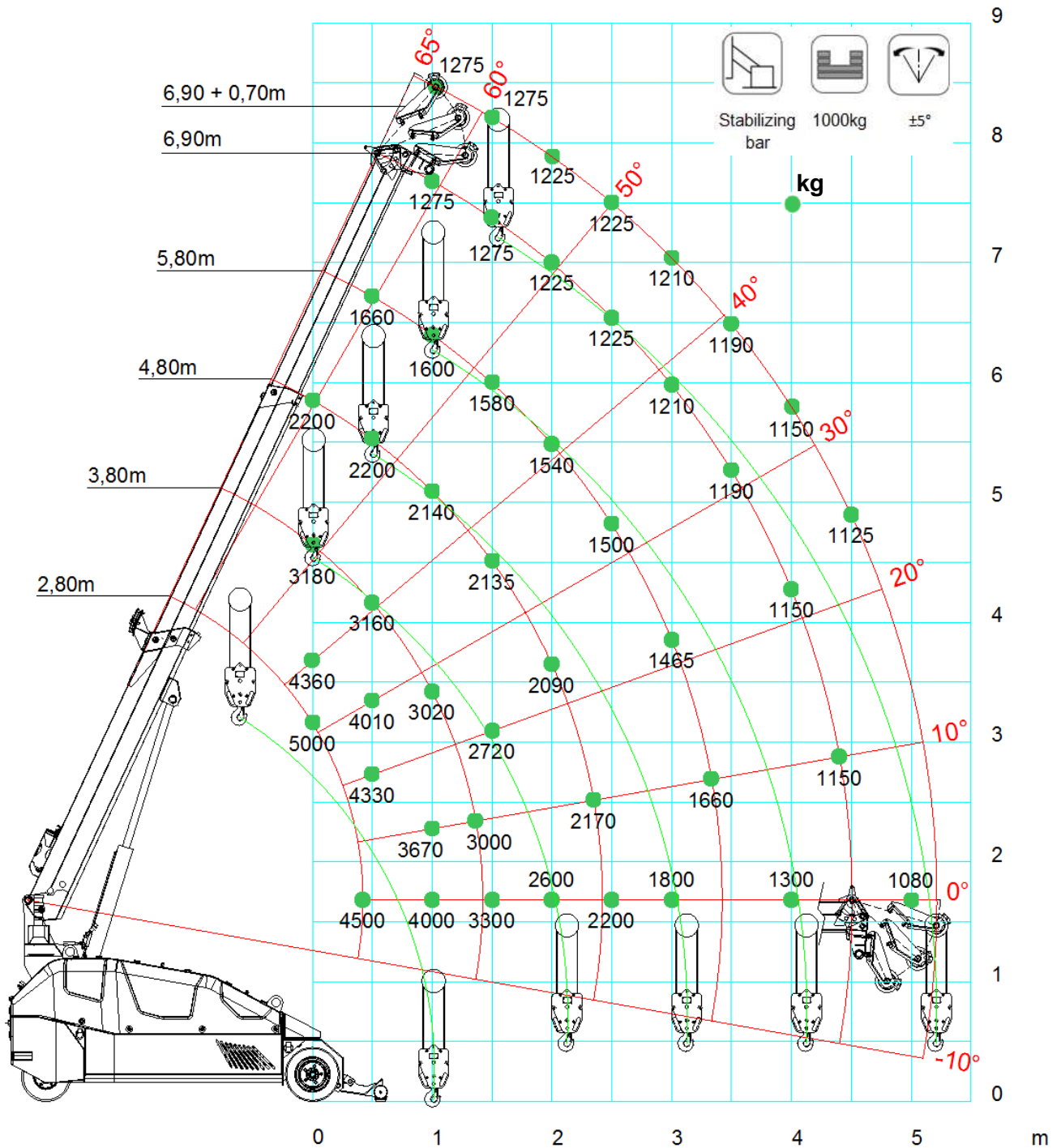

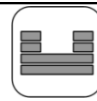
	 WINCH	 Stabilizing bar	 1000kg	 ±5°	 EN
	2,8	3,8	4,8	5,8	6,9
0,0	5000	3180	2200		
0,5	4500	3160	2200	1660	
1,0		3020	2140	1600	1275
1,5		3020	2135	1580	1275
2,0			2090	1540	1225
2,5			2040	1500	1225
3,0				1465	1210
3,5				1430	1190
4,0					1150
4,5					1125
4,9					1100





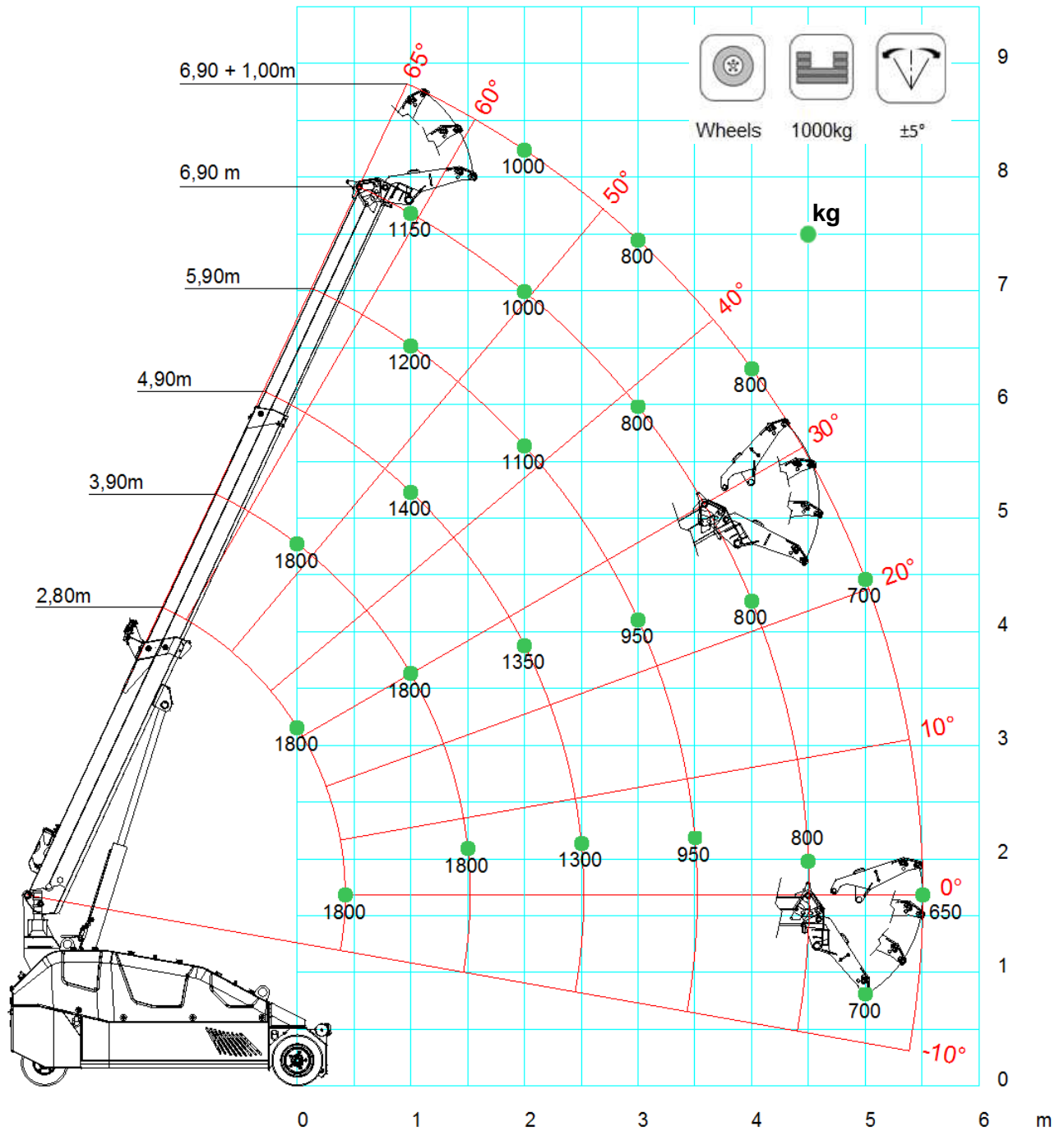

LCMPK50_V102_0616_MAIN_A1_F_CW_1000_BAR

	 WINCH	 Stabilizing bar	 0kg	 ±5°	 EN
	2,8	3,8	4,8	5,8	6,9
0,0	4750	2860	1990		
0,5	4000	2720	1990	1640	
1,0		2550	1870	1470	1250
1,5		2340	1795	1400	1075
2,0			1600	1235	1010
2,5			1450	1150	960
3,0				1060	885
3,5				1000	825
4,0					800
4,5					775
4,9					750



LCMPK50_V102_0616_MAIN_A1_F_CW_0_BAR

MPK50 JIB1800-700.2M Short Wheels



	    				
	SHORT	Wheels	1000kg	±5°	
	2,8	3,9	4,9	5,9	6,9
0,0	1800	1800			
0,5	1800	1800	1400	1200	
1,0	1800	1800	1400	1200	1150
1,5		1800	1400	1150	1100
2,0		1800	1350	1100	1000
2,5		1800	1300	1000	850
3,0			1250	950	800
3,5			1230	950	800
4,0				900	800
4,5				900	800
5,0					700
5,5					650



LCMPK50_V102_0616_JIB 1800_A1_G_CW_1000_WHEEL

	    				
	SHORT	Wheels	0kg	±5°	
	2,8	3,9	4,9	5,9	6,9
0,0	1800	1500			
0,5	1800	1500	1200	900	
1,0	1800	1400	1200	900	700
1,5		1300	1100	800	700
2,0		1100	950	800	600
2,5		950	800	700	550
3,0			700	600	500
3,5			600	550	450
4,0				500	420
4,5				400	400
5,0					380
5,5					300



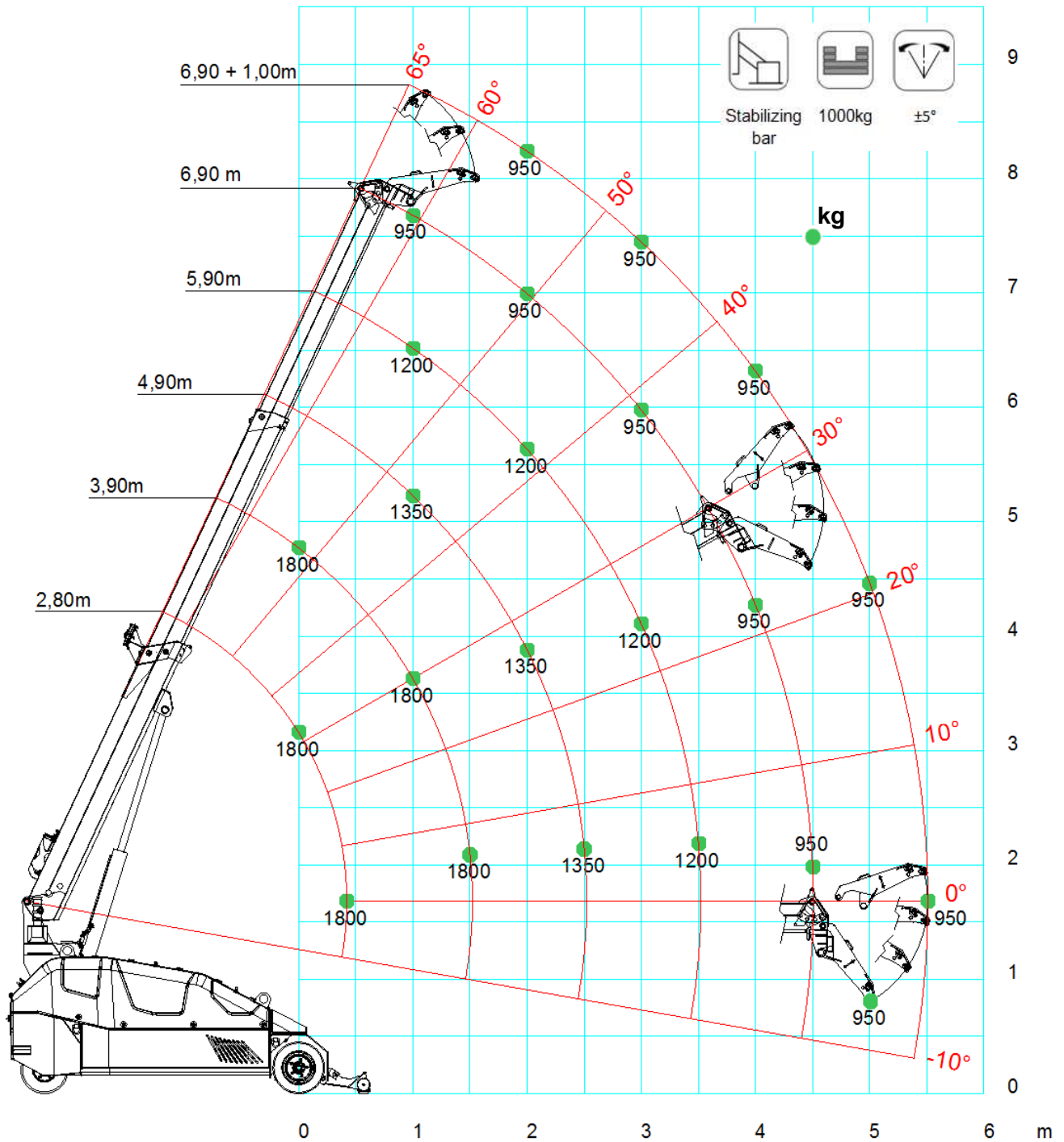



LCMPK50_V102_0616_JIB 1800_A1_G_CW_0_WHEEL

MPK50 JIB1800-700.2M Short Stabilizing bar



					
	SHORT	Stabilizing bar	1000kg	±5°	
	2,8	3,9	4,9	5,9	6,9
0,0	1800	1800			
0,5	1800	1800	1350	1200	
1,0	1800	1800	1350	1200	950
1,5		1800	1350	1200	950
2,0		1800	1350	1200	950
2,5		1800	1350	1200	950
3,0			1350	1200	950
3,5			1350	1200	950
4,0				1200	950
4,5				1200	950
5,0					950
5,5					950





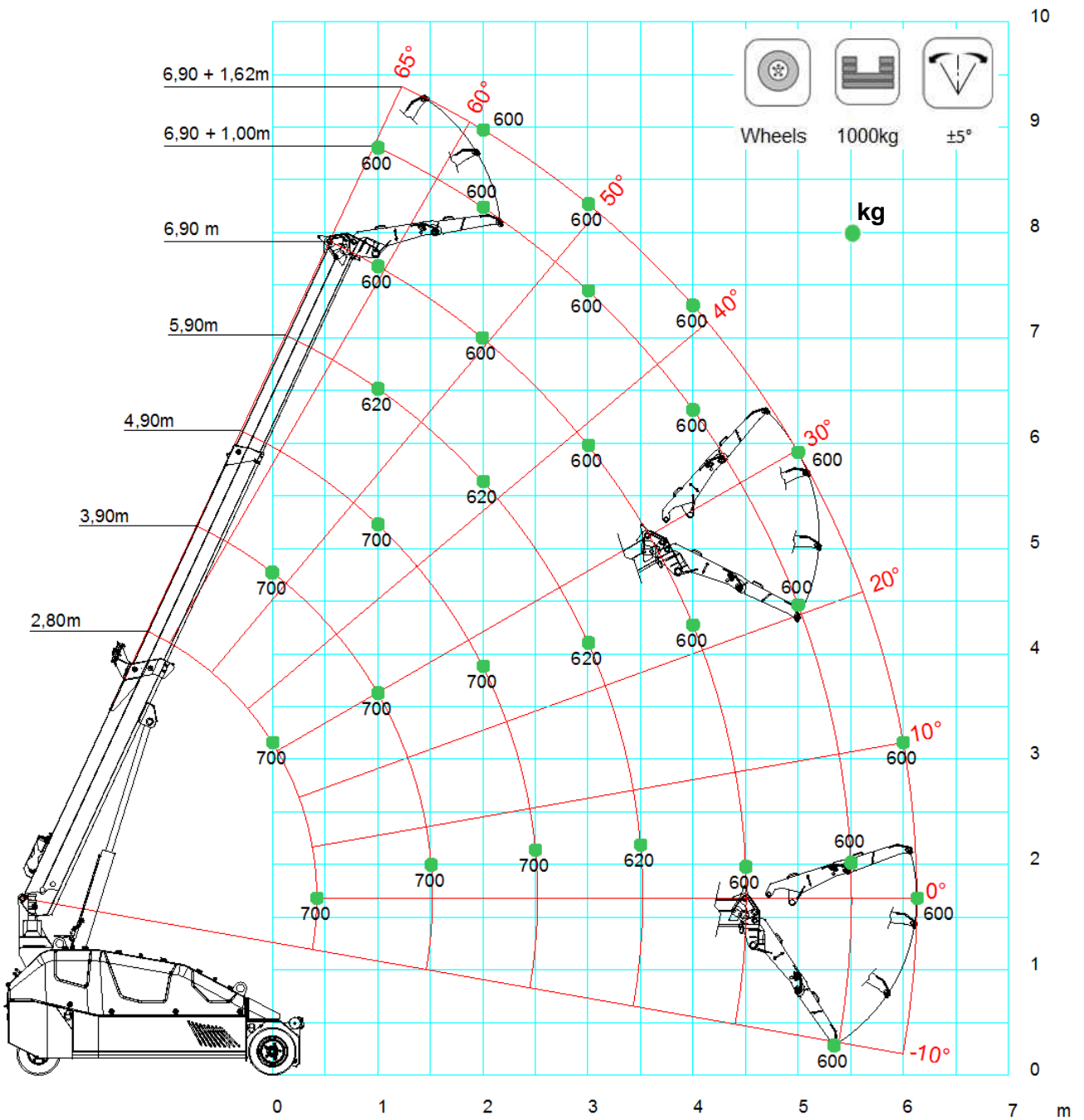

LCMPK50_V102_0616_JIB 1800_A1_G_CW_1000_BAR

					
	SHORT	Stabilizing bar	0kg	±5°	
	2,8	3,9	4,9	5,9	6,9
0,0	1800	1650			
0,5	1800	1650	1275	1050	
1,0	1800	1600	1275	1050	825
1,5		1550	1225	1000	825
2,0		1450	1150	1000	775
2,5		1400	1075	950	750
3,0			1025	900	725
3,5			950	875	700
4,0				850	685
4,5				800	650
5,0					600
5,5					550







LCMPK50_V102_0616_JIB 1800_A1_G_CW_0_BAR

MPK50 JIB1800-700.2M Long Wheels



					
	LONG	Wheels	1000kg	±5°	
	2,8	3,9	4,9	5,9	6,9
0,0	700				
0,5	700	700			
1,0	700	700	700		
1,5	700	700	700	620	600
2,0	700	700	700	620	600
2,5		700	700	620	600
3,0		700	700	620	600
3,5			700	620	600
4,0			650	620	600
4,5				620	600
5,0				620	600
5,5					600
6,1					600





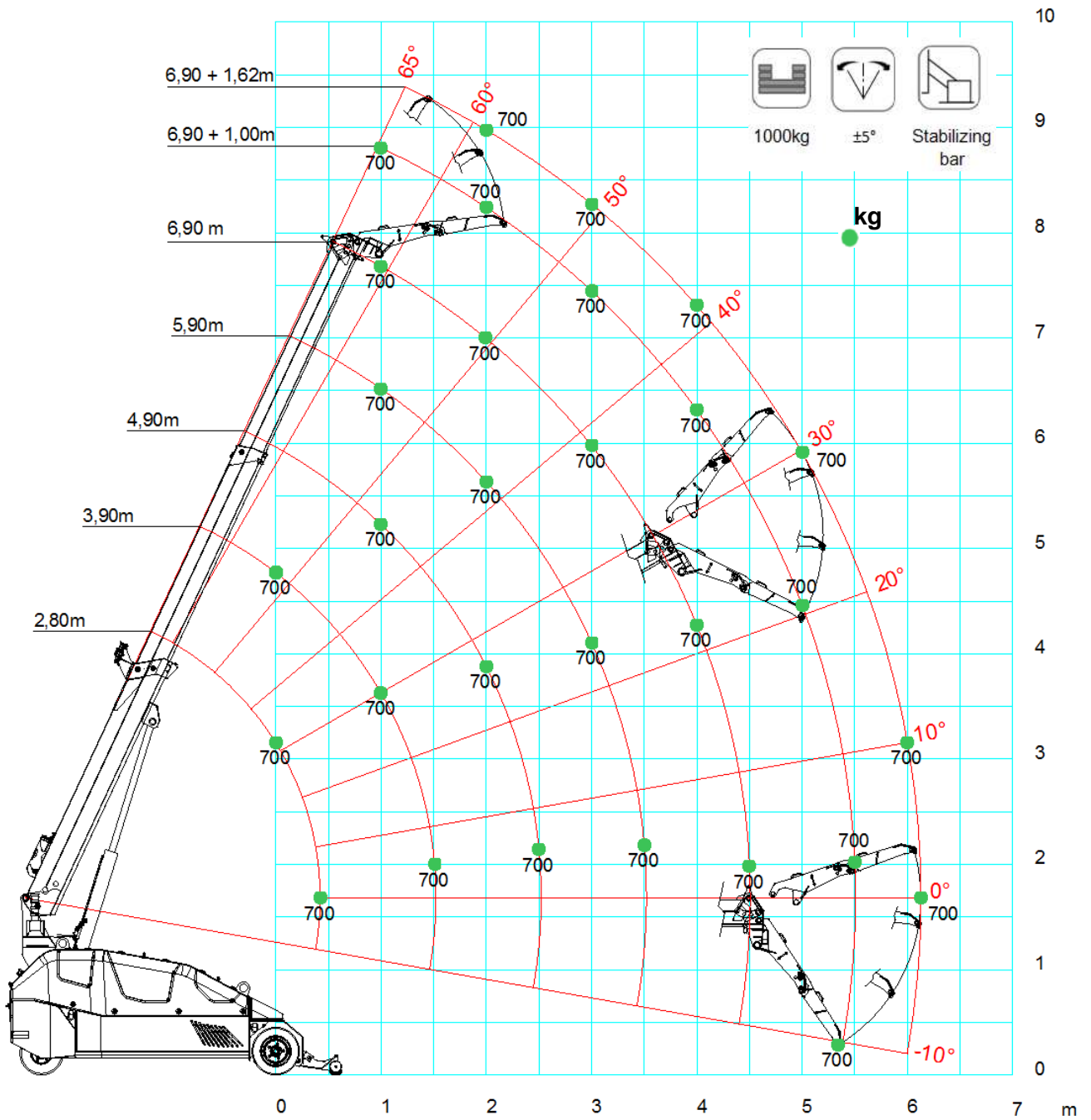

LCMPK50_V102_0616_JIB700_A1.G_CW_1000_WHEEL

					
	LONG	Wheels	0kg	±5°	
	2,8	3,9	4,9	5,9	6,9
0,0	700				
0,5	700	700			
1,0	700	700	700		
1,5		700	700	600	500
2,0		700	700	600	500
2,5		700	700	500	450
3,0		700	700	500	450
3,5			600	500	450
4,0			500	500	400
4,5				400	400
5,0				350	350
5,5					300
6,1					200







LCMPK50_V102_0616_JIB700_A1.G_CW_0_WHEEL

MPK50 JIB1800-700.2M Long Stabilizing bar



					
	LONG	Stabilizing bar	1000kg	±5°	
	2,8	3,9	4,9	5,9	6,9
0,0	700				
0,5	700	700			
1,0	700	700	700		
1,5	700	700	700	700	700
2,0	700	700	700	700	700
2,5		700	700	700	700
3,0		700	700	700	700
3,5			700	700	700
4,0			700	700	700
4,5				700	700
5,0				700	700
5,5					700
6,1					700

LCMPK50_V102_0616_JIB700_A1.G.CW_1000_BAR

					
	LONG	Stabilizing bar	0kg	±5°	
	2,8	3,9	4,9	5,9	6,9
0,0	700				
0,5	700	700			
1,0	700	700	700		
1,5		700	700	600	500
2,0		700	700	600	500
2,5		700	700	600	500
3,0		700	700	550	500
3,5			700	550	500
4,0			650	550	500
4,5				550	500
5,0				500	500
5,5					500
6,1					450

LCMPK50_V102_0616_JIB700_A1.G.CW_0_BAR

ACCESSORIES

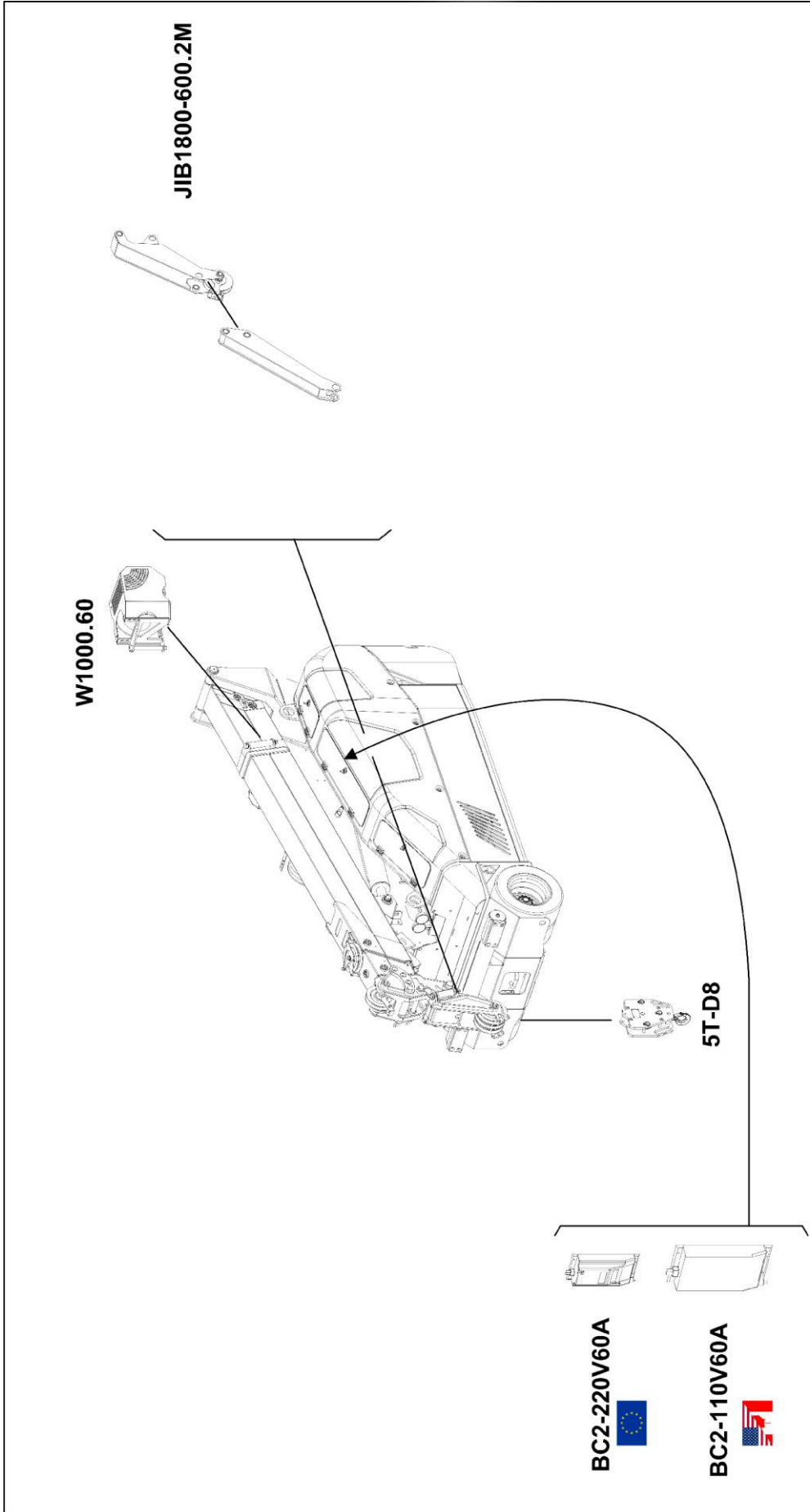

	STD	PC-01	PC-11
Boom, Covers & Outriggers	<input type="checkbox"/> RAL2004	<input type="checkbox"/> RAL_____	<input type="checkbox"/> RAL_____
Chassis, Frames & Tanks	<input type="checkbox"/> RAL7001	<input type="checkbox"/> RAL7001	<input type="checkbox"/> RAL_____

ACCESSORIES FEATURES

JIB1800-700.2M Short configuration

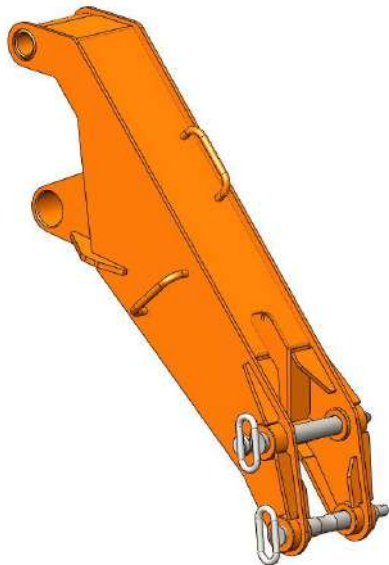
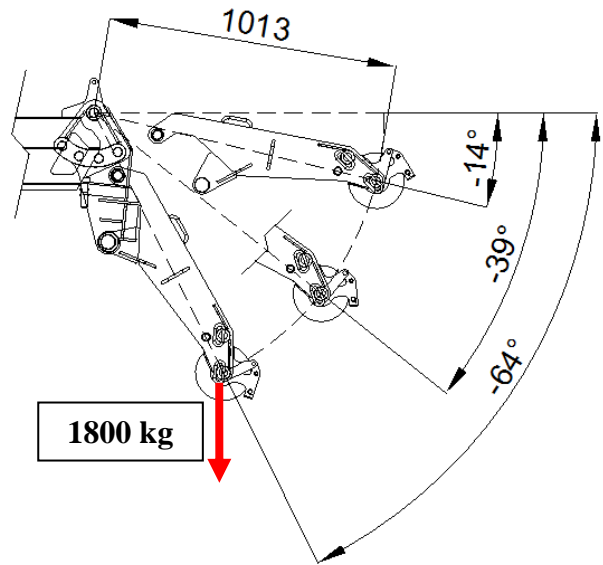
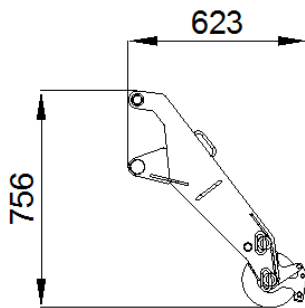
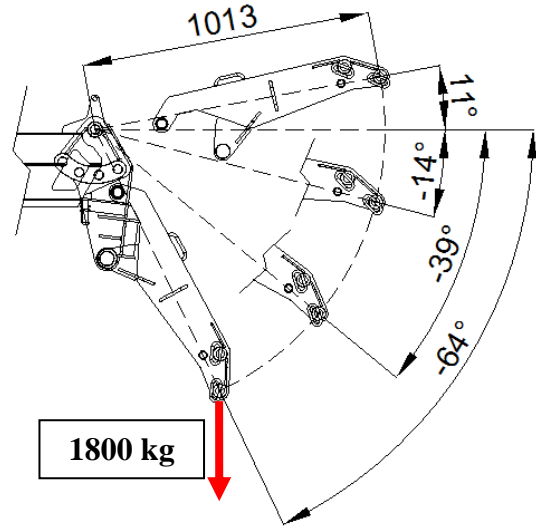
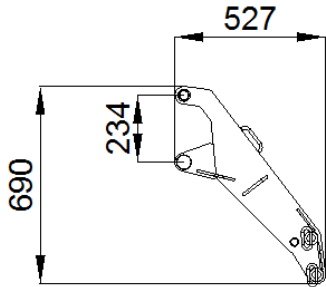

	kg
	30

JIB1800-700.2M
Long configuration

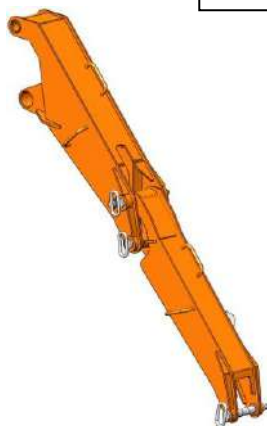
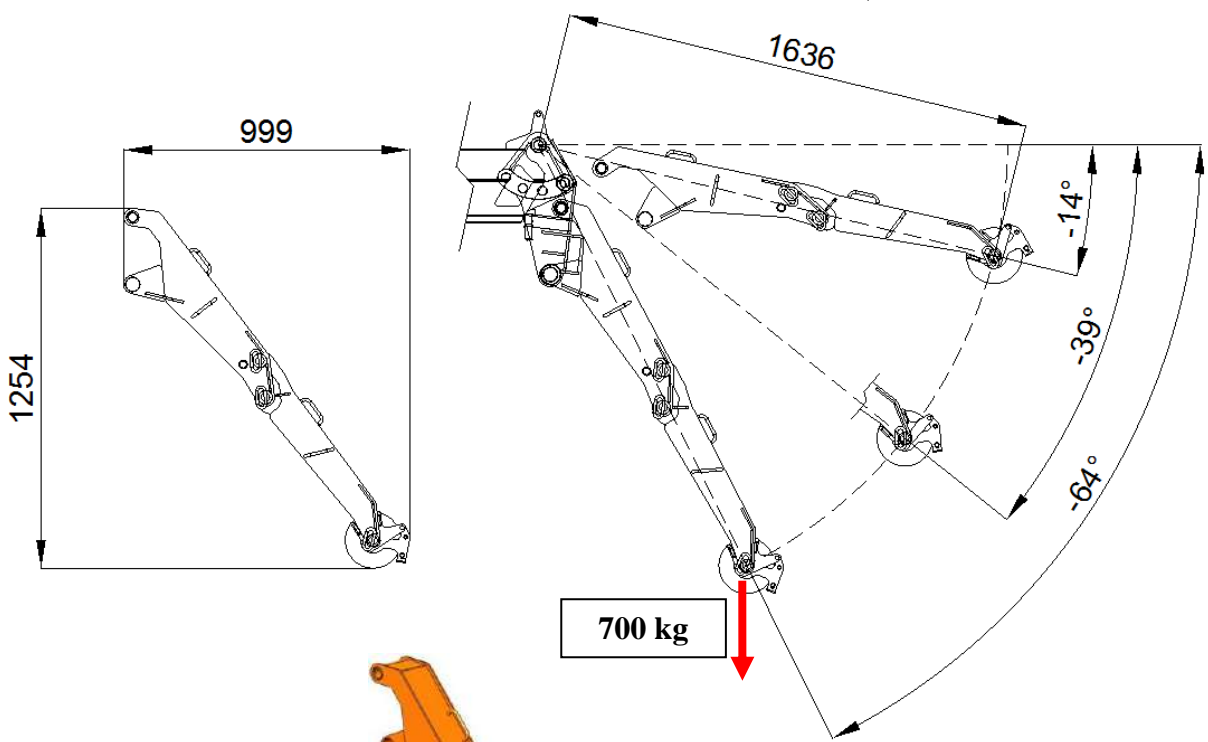
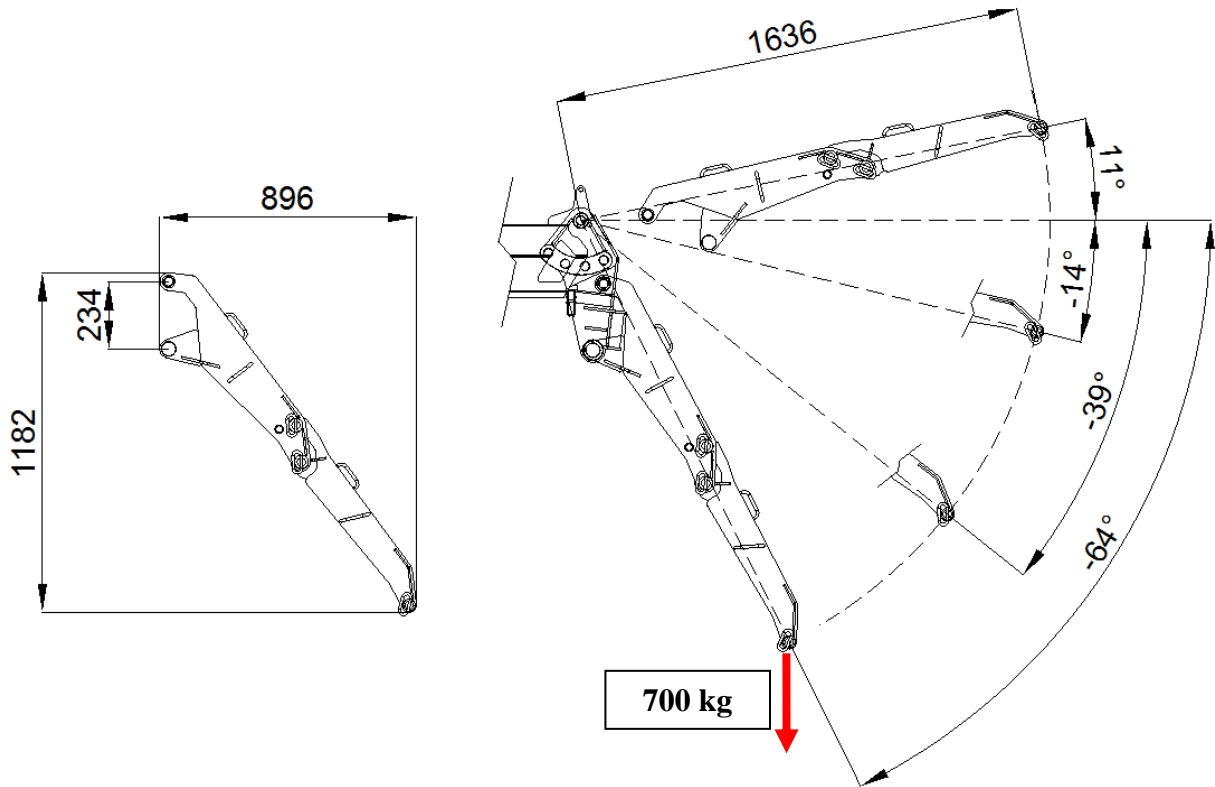

	kg
	30+20

	Weight		Chart Wheels		Engine		Jib length and angle
	Counterweight		Minipicker		Diesel Fuel		Jib Length
	Crane		Back Wheel Point Loading		Gasoline Fuel		Jib Radius
	Travel Speed		Front wheel Point Loading		Tank		Hydraulic Jib Length
	Gradeability		Travel Speed		Battery		Hydraulic Jib Radius
	Outtrigger Load		Gradeability		Power		Mechanical Jib Length
	Track Loading		Working Radius		Boom Angle		Mechanical Jib Radius
	Outriggers Setup		Hookblock		Boom Length		Manipulator Length
	Ext Tracks Width		Slewing		Boom Radius		Manipulator Radius
	Chart On Tracks		Slewing Locked		Jib Hook Radius		Maximum inclination of the machinery
	Jib on board		Without jib on board		Standard		Stabilizing bar
	Horizontal boom angle		Number of vacuum pads		Factory max. load		Building site max. load

Remarks referring to load chart

- The load charts are calculated according to EN 13000.
- For the calculation of the load charts at least a wind speed of 9m/s (33km/h) and regarding the load a sail area of 1m² per ton load and a wind resistance coefficient of 1.2 on the load have been taken into account. For lifting of loads with large sail areas and/or high wind resistance coefficients the maximum wind speed as stated in the load charts has to be reduced.
- Lifting capacities are given in kilograms.
- The weight of the hook blocks and hooks is part of the load and therefore it must be deducted from the lifting capacities.
- Working radii are measured from the slewing centre.
- The lifting capacities given for the telescopic boom apply if the folding jib is removed.
- Subject to modification of lifting capacities.

A large, empty rectangular box with a thin black border, intended for taking notes.

A large, empty rectangular box with a thin black border, occupying the central portion of the page, intended for taking notes.

A large, empty rectangular box with a thin black border, intended for taking notes.

A large, empty rectangular box with a thin black border, occupying the central portion of the page, intended for taking notes.

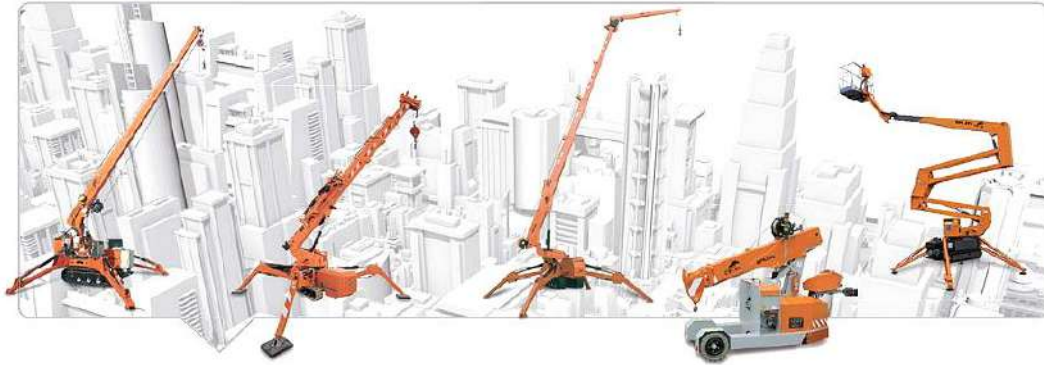

DEALER



JEKKO S.r.l. via Campardone, 1 Z.I. 31014 Colle Umberto (TV)
Italy tel. +39 0438 1710083 fax +39 0438 1710123
www.jekko.it - info@jekko.it